

WorldSkills Asia 2023 Abu Dhabi

Mobile Robotics Pre-Test Project

WSA2023_TP23_pre_EN

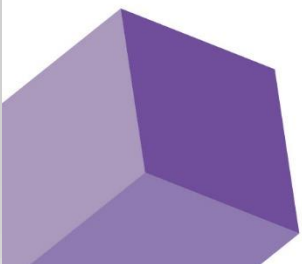

Submitted by:

Bob Tone, Independent Test Project Designer

Reviewed and approved for distribution by:

Tiago Caldeira, Skill Competition Manager

Contents

1.	Introduction.....	3
2.	Instructions to the Competitor	5
2.1.	Remote Clinic Target Objects	5
2.2.	Remote Clinic Support Details	6
2.3.	The Work Order	9
2.4.	Equipment, machinery, installations, and materials required.....	9
3.	Worldskills Occupational Standards Specification (WSOS)	10
4.	Potential Test Project Modules	11
4.1.	Core Robot Performance Elements	11
4.2.	Testing and Fault-Finding.....	12
4.3.	Remote Clinic Support Robot Evaluated Test Run	13
4.4.	Passageway Collision Avoidance Task	13
5.	Building Details	14
5.1.	Remote Clinic (Court)	14
5.2.	Raised Platform (Warehouse and Remote Clinic Supply Room)	15
5.3.	Raised Platforms Center Posts	16
5.4.	Remote Clinic Supply Room Elements.....	17
5.5.	Remote Clinic Court Lighting	18
5.6.	Cutting Patterns	19

1. Introduction

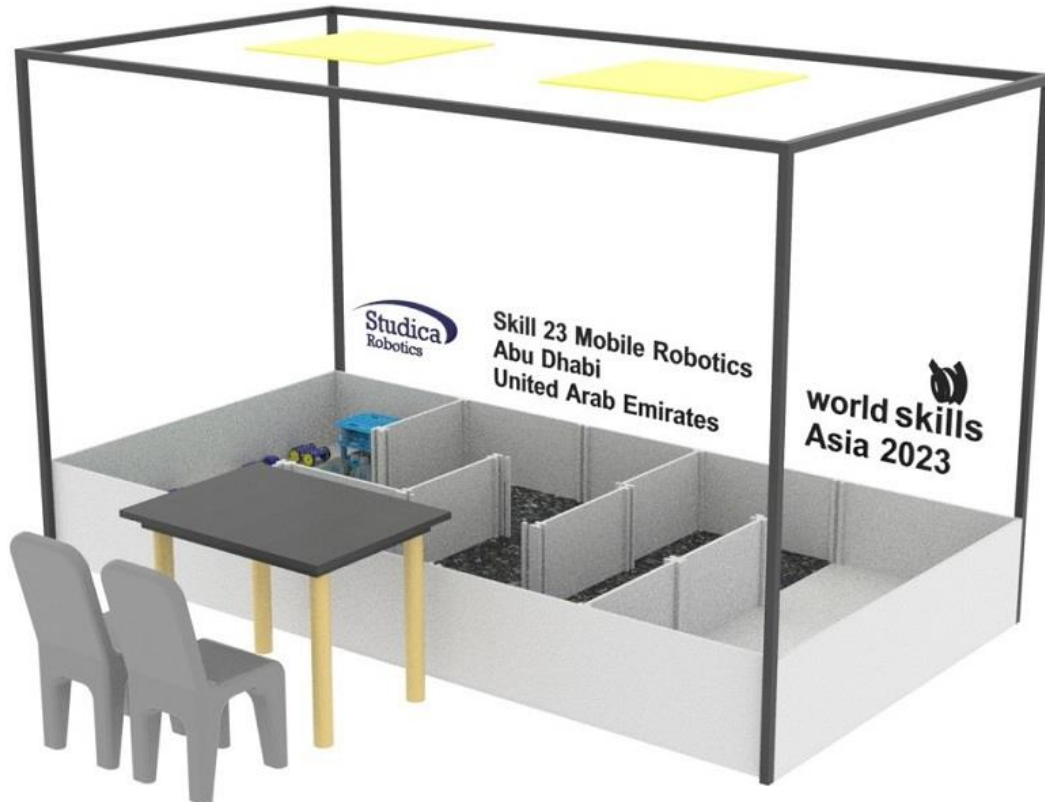

The primary focus of the WorldSkills Asia 2023 Mobile Robotics Pre-Test Project is to have competitors assemble / prepare / manage / repair robots to interpret their environment using 'On the Robot Resources'. It is expected robots will take the environmental information they have gathered and use this information to manage both their overall mobility and target object handling experiences.

In addition, competitors will be required to manage their robot's mobility in a 'Real World Passageway'. This experience will require the robots to demonstrate their robot's ability to detect and avoid colliding with stationary objects located in the "Performance Passageway".

Competitors are expected to identify the Primary Set of Mobile Robot Performance Requirements through analysis of the information provided in this document:

1. Robots are required to Respond to a Work Order Message sent from the Competitor's Laptop,
2. Robots are required to move in Autonomous Control Mode throughout the provided performance evaluation environments, and
3. Robots are required to take control of the various target objects (Cubes/Gurneys) from different initial locations in the Warehouse Area and deliver them to various destination locations in the remote Clinic Supply Room.



The Remote Clinic Performance Environments (Court) presented in this document can serve as inspiration and might be used in the competition, but variations might be available in the event.

The actual Remote Clinic Competition Environments layouts to be used will only be selected and disclosed during the competition, prior to any evaluations.

The task is designed to mimic a real scenario, within a unknown environment and the need to pre-program movement segments between known in advance position points within the court should be minimize or eliminated by the Competitors.

During the competition competitors will have opportunities to test their robots in the courts, but they will not have dedicated time to enter the courts to take specific measurements defining passageway details or target object locations.

In some cases, the competitors could observe the actual court, but not be able to test the robot on the same exact environment.

2. Instructions to the Competitor

The current Pre-Test Project refers to the event, “WorldSkills Asia 2023 - Abu Dhabi” which is expected to take place from the 27th to the 29th of November 2023 in the Abu Dhabi National Exhibition Center (ADNEC) - Abu Dhabi, United Arab Emirates.

The event has 3 competition days (C1, C2 and C3), and it’s expected to be preceded by some Familiarization time prior to the first day of competition.

Competitors are expected to bring their own laptop, custom components and required tools, but they will be provided with a new Studica Mobile Robotics Collection Lyon 2024 at the event (more details below).

2.1. Remote Clinic Target Objects

There are FOUR Target Objects with which the Mobile Robots must interact:



There are Four 65 mm by 65 mm by 65 mm Medicine Cubes (2 White and 2 Blue) and Two ‘Clean’ HazMAT Cubes (Yellow).



There are Two Gurneys.

Robots may be in possession of a Maximum of TWO Target Objects at a time.

- 2 Cubes of any kind,
- 2 Gurneys or
- 1 Gurney and 1 Cube

Gurney #75102		
Qty	Product	Part #
1	192mm x 96mm Flat Bracket	76066
2	L Bracket (2 pack)	76087-2
2	6mm x 140mm D-Shaft	76164
4	Bronze Bushing 6mm ID x 14mm OD	76301
4	75mm Drive Wheel - 60A, 12.5mm wide, 1/2" Inner Hex, Black	76271
1	Shaft Spacer Plastic 6mm ID x 10mm OD x 1mm L (24 pack)	76305-24
1	6mm Shaft Hub (4 pack)	76284-4
1	M3 Kep Nut (pack of 100)	76204-100
1	M3 x 10mm Socket Head Cap Screw (pack of 100)	76201-100

2.2. Remote Clinic Support Details

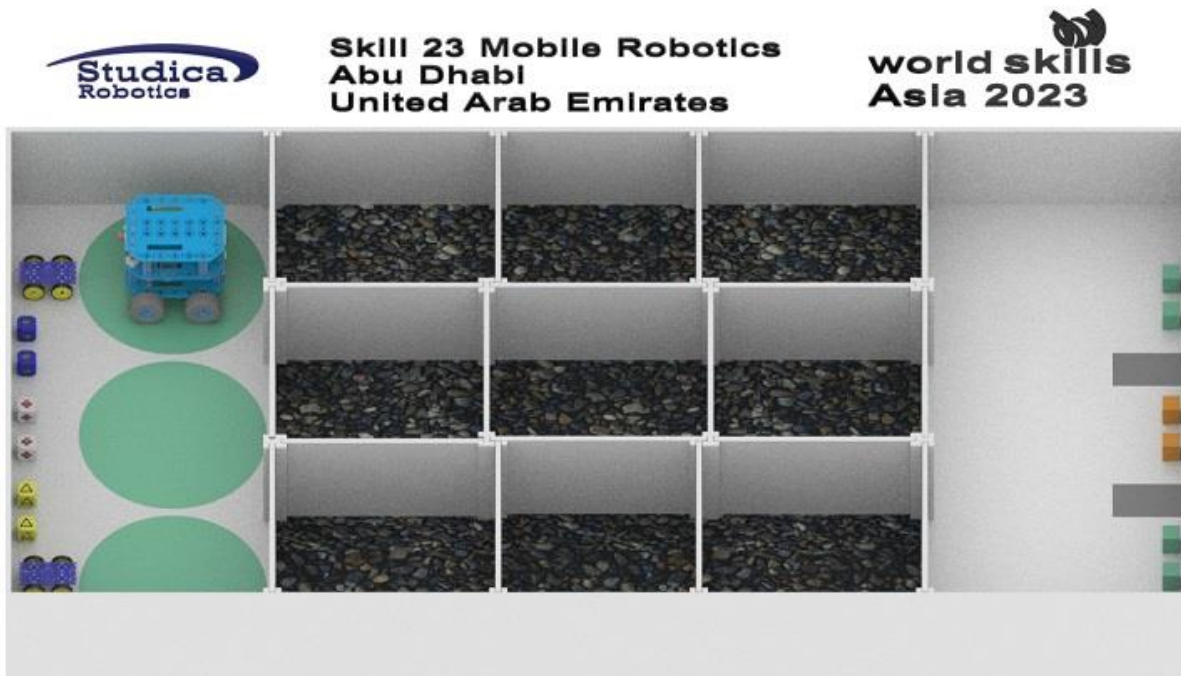

The WorldSkills Asia 2023 - Abu Dhabi Mobile Robotics Remote Clinic Support Robot Performance Environment (Court) has 3 Distinct Sections:

- The Warehouse (smooth, hard floor)
- The Central Travel Space (Loose 3/8's Inch Pea Gravel Bed – approx. 76 mm deep)
- The Remote Clinic (smooth, hard floor)

All Three Sections have surrounding (or internal) walls that are a 400 mm tall relative to the surface of each sections floor.

Note: Competitors must realize ALL court walls represent Floor to Ceiling Walls meaning that NO Part of their Robot or of the Target Object(s) the Robot is carrying is allowed to be in the space above any of the court walls (i.e., the robot should act as if there were 'invisible' walls extending vertically the existing ones with infinite height).



The Surface (Floor) of the Travel Zone will be a 2200 by 2000 by 76 mm deep (Same height as the Warehouse and Remote Clinic Supply Room Floor) bed of 3/8's inch Pea Gravel

The Travel Zone can support a variety of Pathways.

There will be multiple Remote Clinic Courts and the layout might be different in each one of the Remote Clinic Support Courts. The differences will be evident in the three areas of the court: the Warehouse (Target Source Area), the Travel Zone (Central area with an irregular surface and internal walls) and the Remote Clinic Supply Room (Target Object Destination Area).

Robots will have a Minimum 600 by 600 mm Operational Space available in ALL Locations within the Remote Clinic Support and the Object Avoidance courts.

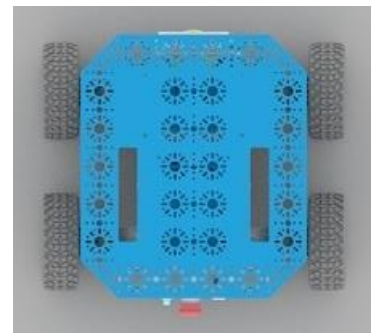
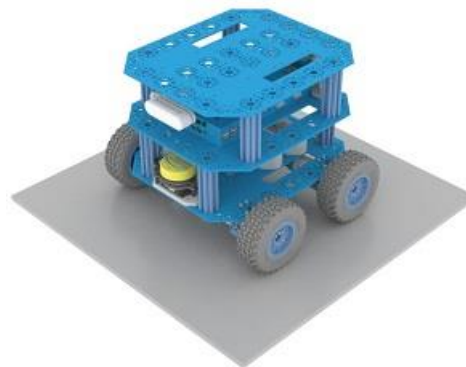

The robots can be higher than the walls (400mm), as there is no Height limitation to their design.

The sample Target Object Position Patterns provided below are intended to assist competitors in understanding the potential Source Target Object patterns. They are samples and are NOT intended to be considered the actual layouts that will be used in the event.

In the Warehouse there are multiple options for Robot Starting Positions, 3 options for the Enter / Exit Gate and a Variety of options related to the Cube and Gurney Positions.

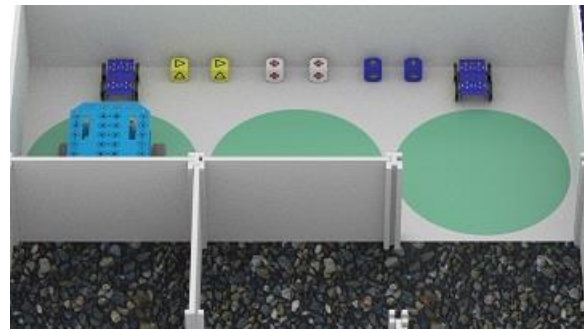
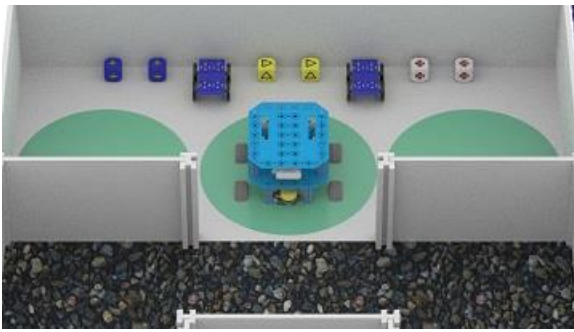

Note: Robots are expected to identify and manage the Target Objects (Cubes and Gurneys) based on their own characteristics. There will be NO signs on the wall of the Warehouse Area or tapelines to assist in target object retrieval.



Target Object Destination / Placement Locations in the Remote Clinic's Supply Room will be identified by:

- The shape and color of the Cube Stands
- The shape and color of the Gurney pads

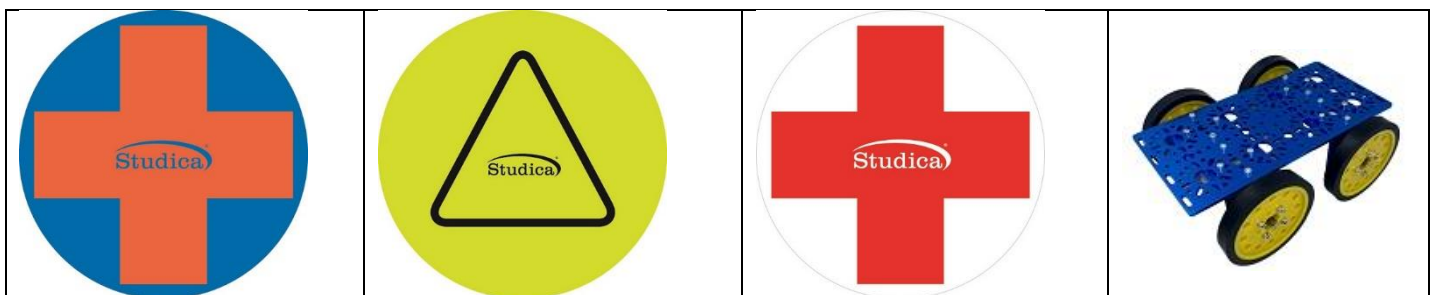

The Wall Plates (shown above) will identify Target Object Destinations in the Remote Clinic Supply Room.

2.3. The Work Order

In Evaluated Test Project Runs, Competitors will not know the work details in advance, they will be told the Work Order Details **AFTER** their robot is in place in the Warehouse Area and ready to start.

Robots will receive their Work Order Details by way of a message sent to the robot from the Competitor's Laptop.

Robots will Light Up the **Green START LED Ring** on the Control Panel to confirm it has received the Work Order Message.



ALL Work Orders might involve Three Target Objects. Given robots are restricted to being 'In Possession' of a Maximum of Two Target Objects at any time, ALL Work Orders will require the robots to **travel to and return from the Remote Clinic Supply Room TWICE** within the available Maximum Time Allotment of 600 Seconds.

2.4. Equipment, machinery, installations, and materials required.

Competitors are expected to develop their mobile Robots using the components provided in the WorldSkills Lyon 2024 Mobile Robotics Collection (Studica).

It is expected that Competitors will design and build a complete mobile robot during the competition preparation experiences (at-home/school), prior to the competition, but Competitors must not bring to the event the robot built during their preparation experiences.

Competitors will be provided with a new WorldSkills Lyon 2024 Mobile Robotics Collection in the competition space, which will be used to assemble the official robot during their runs. Competitors can incorporate 'Competitor Designed/Created Custom Components' into their robot design, which can be brought to the competition, but should follow the constrains:

- All 3D-Printed elements must be created using ABS, PLA, Nylon, PETG, HIPS, ASA, or Carbon Filled Fiber.
- All components developed using sheet material must be created using any polycarbonate material with a maximum thickness of 10 mm.
- All manufactured components (including spares) should have a maximum overall weight of 1.5 Kg.
- Competitors are also allowed to bring custom cabling and electrical wires required for the robot's wiring, but not active.

Competitors are required to bring three copies of the Micro SD Card used on the VMX (ready to be used). This is due to the restriction of no internet on-site, which means all packages and software must be installed ahead of time.

3. Worldskills Occupational Standards Specification (WSOS)

The WSOS determines knowledge, understanding and specific skills that underpin best international practices of technical and professional work performance levels. It should reflect a shared global understanding of what associated working specialty or profession means for industry and business.

The skill competition purpose is to demonstrate best international practices as described by the WSOS to the extent they are able to be implemented. The WSOS is therefore a guide to the required training and preparation for the skill competition.

In skill competitions knowledge and understanding will be checked through the assessment of the performance of practical work. There will be no separate tests of knowledge and understanding.

The WSOS is divided into clearly-defined sections with numbers and headings. Each section is assigned with a relative percentage of importance within the WSOS framework. The sum of all relative importance percentages is 100.

The Marking Scheme and the Test Project for Worldskills Asia will assess only those skills that are set out in the WSOS for Worldskills Lyon 2024. They will reflect the WSOS as comprehensively as possible within the constraints of the skill competition. The Marking Scheme and the Test Project will reflect the allocation of marks within the WSOS Lyon 2024 to the maximum possible extent, but fluctuations are allowed (10%) upon the condition they will not distort the weightings specified by the overall WSOS conditions.

4. Potential Test Project Modules

Full details on the exact modules will only be released during the competition on the final test project, or during the Competition Briefings. Besides the design/build of a robot as part of the preparation, the Competitors should focus in developing their necessary skills related with Mobile Robotics.

The following tasks are sample of what can be expected to be included on the final test project to evaluate the competitors skills:

- Core Robot Performance Elements
- Testing and Fault-Finding
- Evaluated Test Project Run Experience
- Passageway Collision Avoidance

Note: The final Test Project and Schedule will only be revealed during the competition as part of the familiarization day, or morning briefings with the competitors.

4.1. Core Robot Performance Elements

During the competition, Robots will be required to complete a set of Core Robot Performance Elements in the Remote Clinic Courts.

The following Performance Experiences represent ‘Samples’ of the type of Individual Evaluated CORE Performance Experiences Robots will be required to complete.

- Target Object Recognition: Cube
- Take Possession of a Cube
- Travel through Open Space Hard / Smooth Surface in possession of a cube
- Travel through Open Space Gravel in possession of a cube
- Target Object Recognition: Gurney
- Take Possession of a Gurney
- Travel through Open Space Hard / Smooth Surface in possession of a Gurney
- Travel through Open Space Gravel in possession of a Gurney
- Travel through a 90 degree turn in a Gravel passageway in possession of a Gurney
- Target Object Recognition: Medicine Cube Stand / Wall Plate
- Target Object Recognition: Gurney Pad / Wall Plate
- Deliver a Medicine Cube onto a Medicine Stand
- Deliver a HazMAT Cube onto a HazMAT Stand
- Deliver a Gurney onto a Gurney Pad

Note: The specific set of Core Robot Performance Elements will be presented to competitors during the Competitor Information Meeting.

4.2. Testing and Fault-Finding

The Testing and Fault-Finding module focuses on the competitor's ability to complete an inspection check list to test and find faults in given hardware (assembled sample robot). The faults could be divided in 4 sections: Electrical, Mechanical, Sensors, and General Robot Operation using tele- operation (Gamepad). Competitors will be given a sample assembled robot and they might be required to diagnose and report any faults, identify the corrective action required and in some cases execute the repair.

Competitors will be briefed on the task in the morning briefing. The type of check will be either visual or functional. A sample computer with driver station and shuffleboard could be provided to enable the completion of the tasks if required. Competitors can't use their own robots, or laptops during this task.

 Inspection Checklist		
Date: _____	Country: _____	
Name: _____	Robot ID: _____	
Inspection Task	Type of Check (V = Visual, F = Functional)	Comments and Corrective Action to be taken
Electrical		
Robot turns on		
Robot turns off and battery disconnected		
Cable between battery and control panel		
Cable between control panel and Titan		
All terminals with a wire are secure		
Check battery connectors		
Check battery fuse		
Check battery voltage		
Check Titan fuses		
Emergency stop is wired		
No damaged wires		
Titan I/O pins are ok		
VMX Connections are ok		
VMX has 3 green LEDs		
VMX terminating shunt is present		
VMX I/O Voltage		
Mechanical		
No loose screws or nuts		
Wheels, Track or Rollers show no damage		
Wear Level of above		
Signs of damage to channel or brackets		
3D Printed parts show no damage		
Polycarbonate parts show no damage		
Nothing is hanging off chassis		
Sensors		
Ultrasonic sensor showing correct distance		
Sharp sensor showing correct distance		
Yaw value is correct		
Cobra reacts to black or white		
Encoders give correct counts		
Camera is functional		
Operation		
Motors move		
Servos move		
DMS picks up object		
Robot stops if E-Stop is pressed		
Expert #1: _____	Expert #2: _____	Expert #3: _____

The above image is a potential inspection checklist that competitors could use as inspiration.

4.3. Remote Clinic Support Robot Evaluated Test Run



A different Remote Clinic Support Robot Court Layout will be used each day of the competition with each of these layouts presenting a different pattern of Travel Area barriers and Warehouse / Remote Clinic Supply Room Enter / Exit Gates.

Competitors may have Evaluated Test Runs in different Remote Clinic Support Robot Court Layouts.

Note: The layout shown above is shown with the NO Barriers in the Gravel Travel Area as a sample.

4.4 Passageway Collision Avoidance Task

The Passageway Collision Avoidance Task requires Competitors to use their Remote Clinic Support Robot in a different performance environment.

The Passageway Collision Avoidance Court involves:

- A surprise passageway will be placed within a 5m x 5m area and will have at least 600mm wide spacing for the navigation of the robot.
- The Passageway Walls are 400 mm tall.
- The Passageway floor is the default facility floor.
- The Passageway lighting is the default facility lighting.
- There robots start and finish location will be defined.

Note: Competitors will be provided a block of at least 3h within the competition to prepare for their Passageway Task Experience including both Preparation and Evaluation Experience Time. Competitors might have more than one Evaluated Passageway test runs. Details on the timing and evaluation will be provided during the competition time.

- A collection of Stationary Obstacles, which the robots are expected to first detect and then avoid hitting while traveling from the start to end of the passageway, will be introduced into the passageway AFTER the competitor's robot has been placed in the starting position.
- Competitors will be provided with samples of these obstacles for use at their workstation.
- Competitors will not be provided with any descriptive details regarding these obstacles until the Competitor Information Meeting on the evaluation day.
- Competitors will NOT be allowed to bring their robot to the Passageway court at any time during their task preparation period.

5. Building Details

5.1. Remote Clinic (Court)

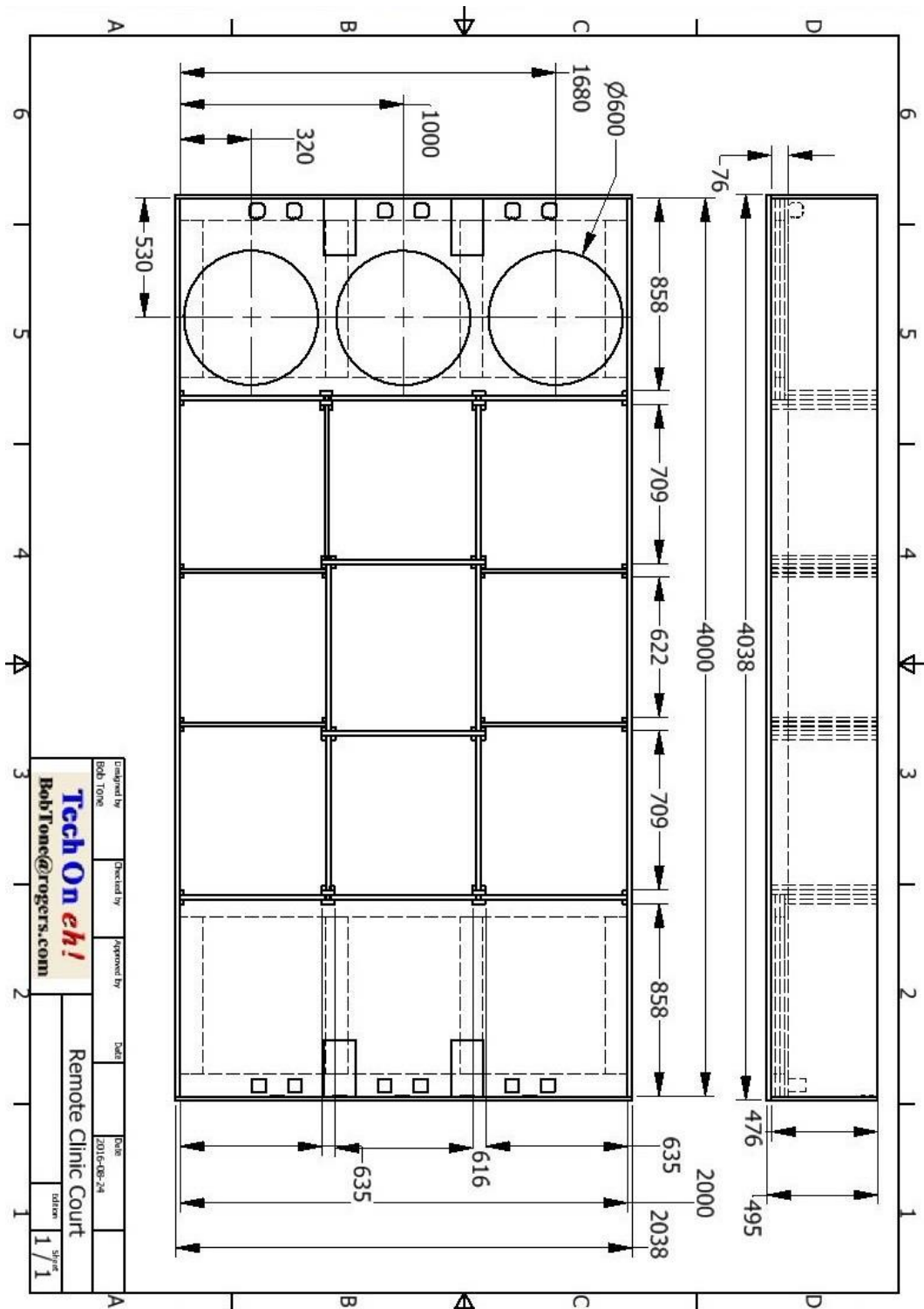

5.2. Raised Platform (Warehouse and Remote Clinic Supply Room)

THIS MATERIAL LIST IS FOR ONE RAISED PLATFORM. TWO RAISED PLATFORMS ARE REQUIRED.

THE 19 mm MATERIAL THICKNESS WILL DEFAULT TO THE CLOSEST STANDARD SIZE AVAILABLE IN THE UAE.

PARTS LIST			
ITEM	QTY	PART NUMBER	DESCRIPTION
1	6	Long Floor Support	2000 by 100 by 19
2	12	Short Floor Support	700 by 100 by 19 mm
3	1	Floor Plate	2000 by 900 by 19 mm

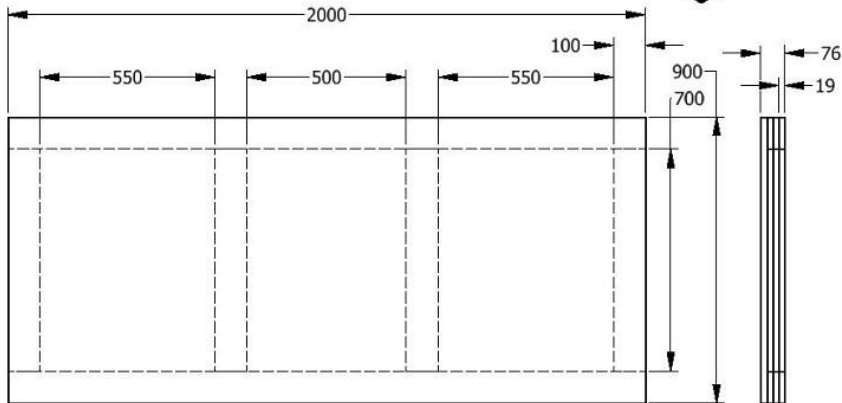
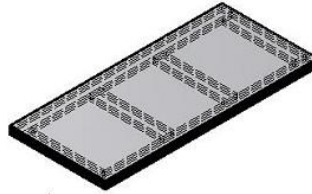

The Barriers

THIS THE 19 mm MATERIAL THICKNESS WILL DEFAULT TO THE CLOSEST STANDARD SIZE AVAILABLE IN THE UAE.

PARTS LIST			
ITEM	QTY	PART NUMBER	DESCRIPTION
1	6	Enter / Exit Barriers	650 BY 400 BY 19 mm
2	4	Passageway Barrier	654 by 476 by 19 mm
3	4	Passageway Barrier	686 by 476 by 19 mm
4	2	Passageway Barrier	730 by 476 by 19 mm
5	2	Passageway Barrier	740 by 476 by 19 mm

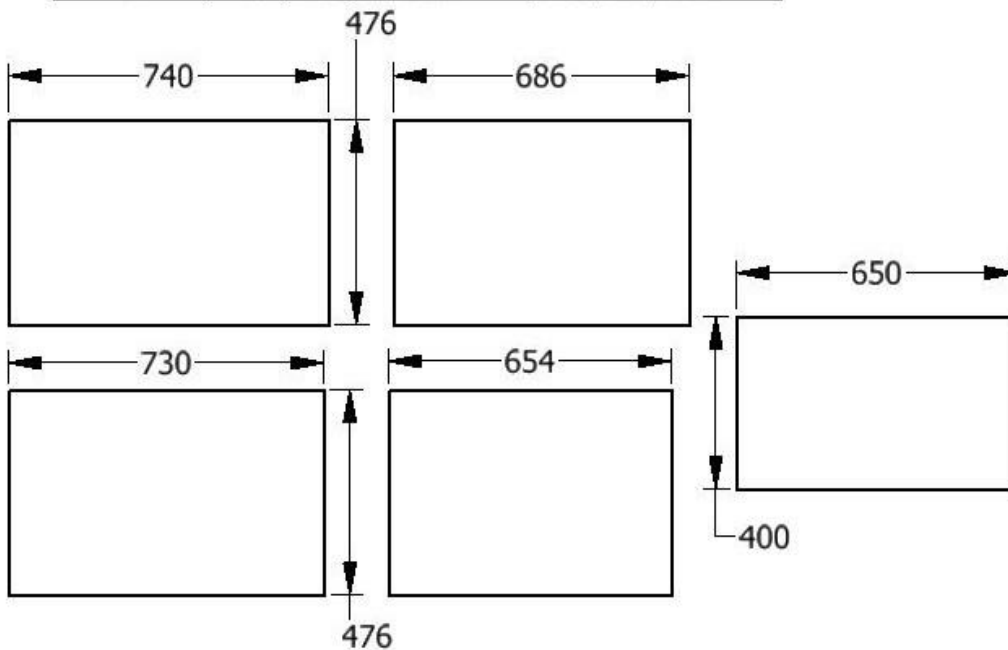

5.3. Raised Platforms Center Posts

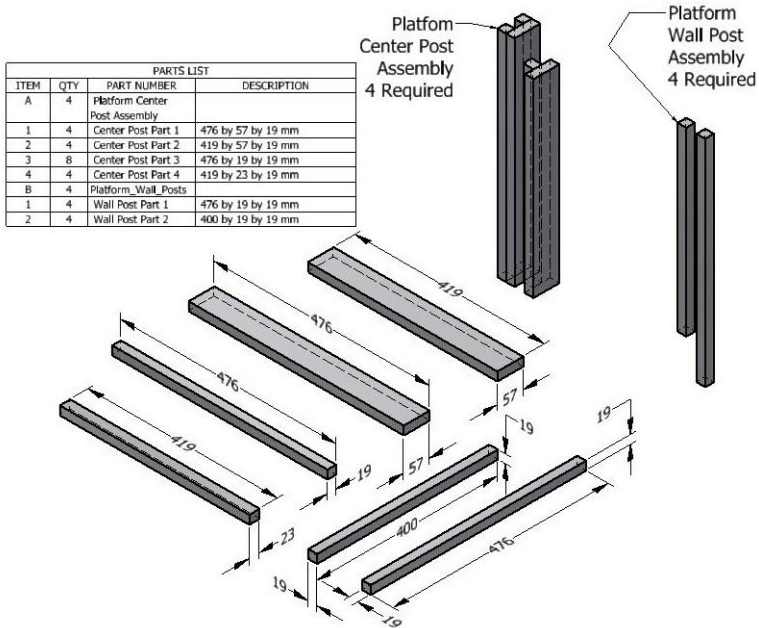

Center Barriers

PARTS LIST			
ITEM	QTY	PART NUMBER	DESCRIPTION
1	A		Center Barrier Assembly 1
2	2	730 by 476 by 19 mm	Center Barrier Plate 1
3	16	476 by 19 by 19 mm	Barrier Post
4	B		Center Barrier Assembly 2
5	2	740 by 476 by 19 mm	Center Barrier Plate 2
6	4	476 by 19 by 19 mm	Barrier Post

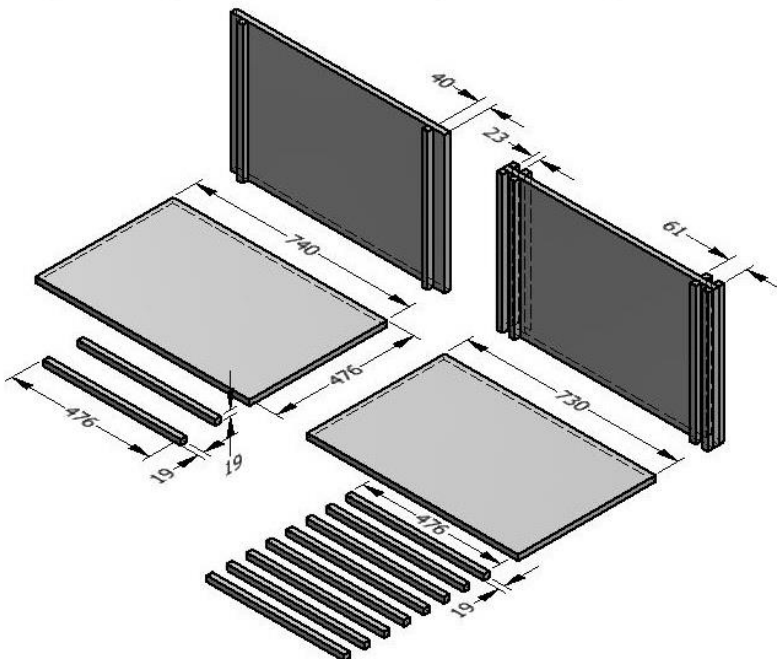

	
<p>Wall Posts</p>	<p>Center Travel Area 3/8's inch Pea Gravel Bed 2200 by 2000 by 76 mm</p>

5.4. Remote Clinic Supply Room Elements

- Four Green 80 by 60 by 60 mm Medicine Cubes are required.
- Two Red 80 by 60 by 60 mm Medicine Cubes are required.
- Two 250 by 142 mm Black Vinyl Gurney Pads
- Three circles Start / End Robot Pads (Dia. 600 mm)

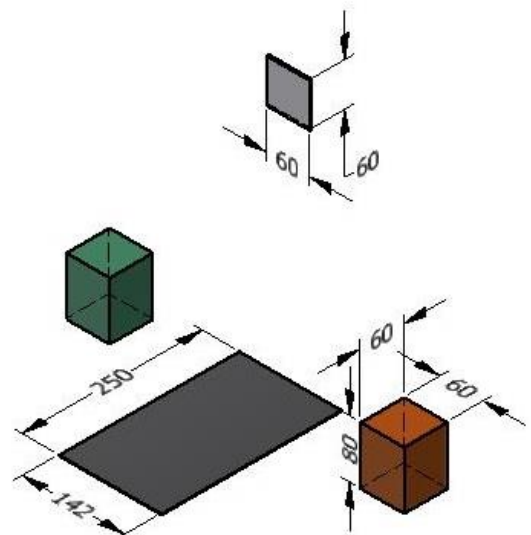

NOTE: The exact RGB values or CMYK values related to these objects will NOT be provided.

5.5. Remote Clinic Court Lighting

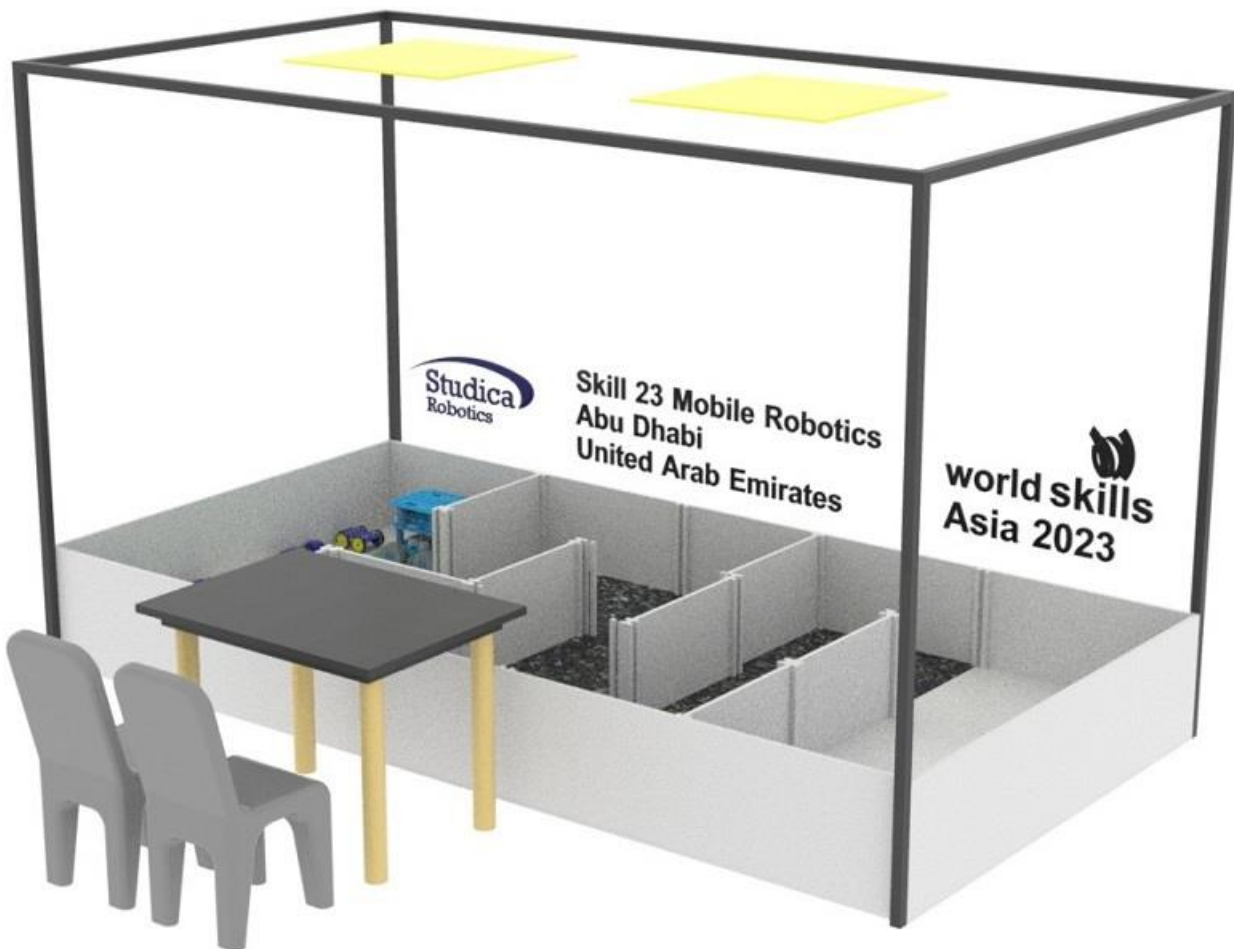

Two square LED Light Panels will be positioned over each Remote Clinic Court. The height of the frame will be set to ensure the lights are well above the head of a competitor standing in the court under these lights.

The material used for the required frame structure and the specific LED Lights will be set by the Workshop Manager based on availability in the United Arab Emirates.

5.6. Cutting Patterns

The next set of images display the cutting patterns that will enable seven **1220 by 2440 mm sheets** of White Melamine to provide the parts required to build **ONE** Remote Clinic Court.

Note: The images in this document reference 19 mm thick Melamine. However, the melamine Sheeting used in the event will be the closest to 19 mm standard size available, but variations are expected.

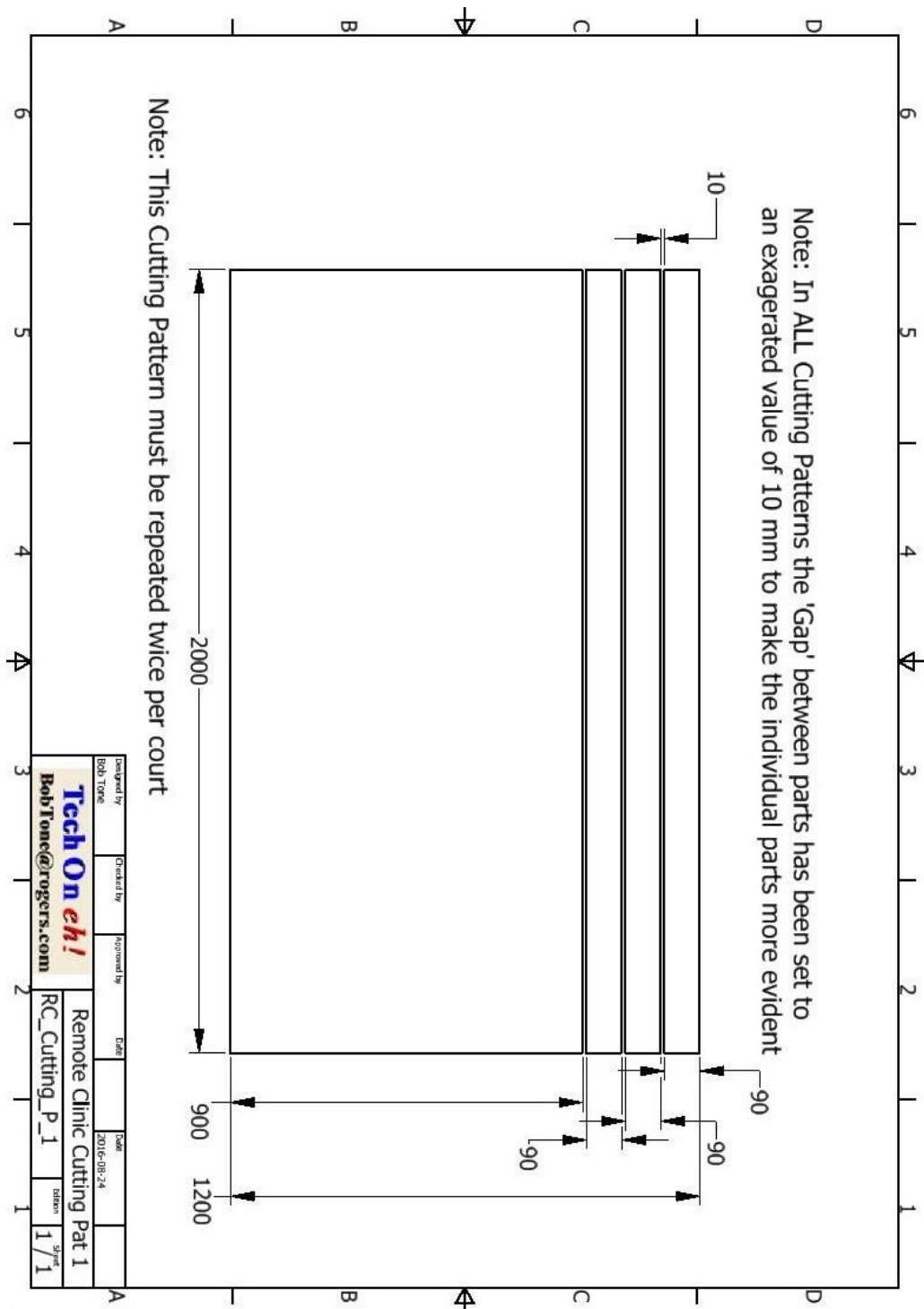

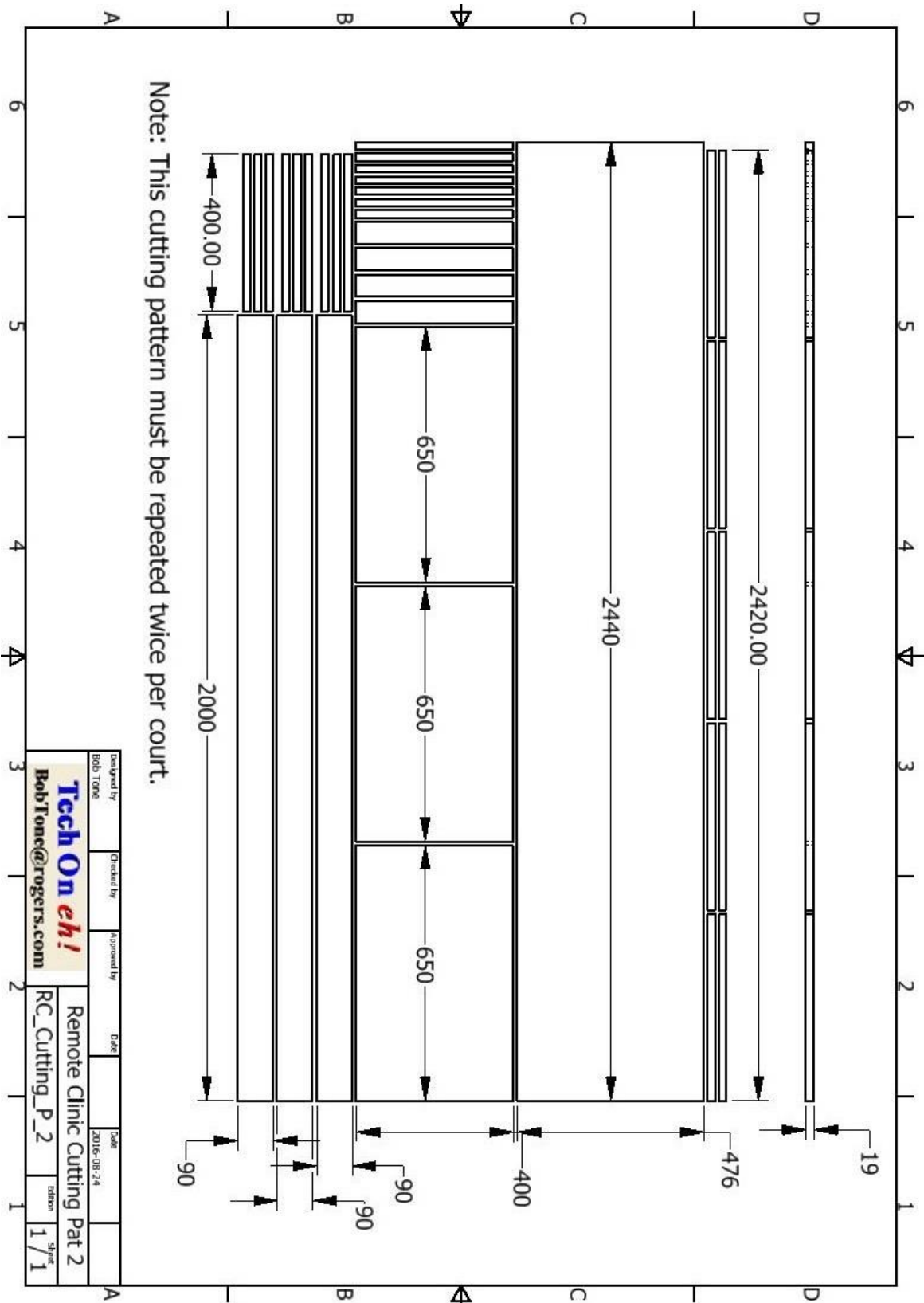

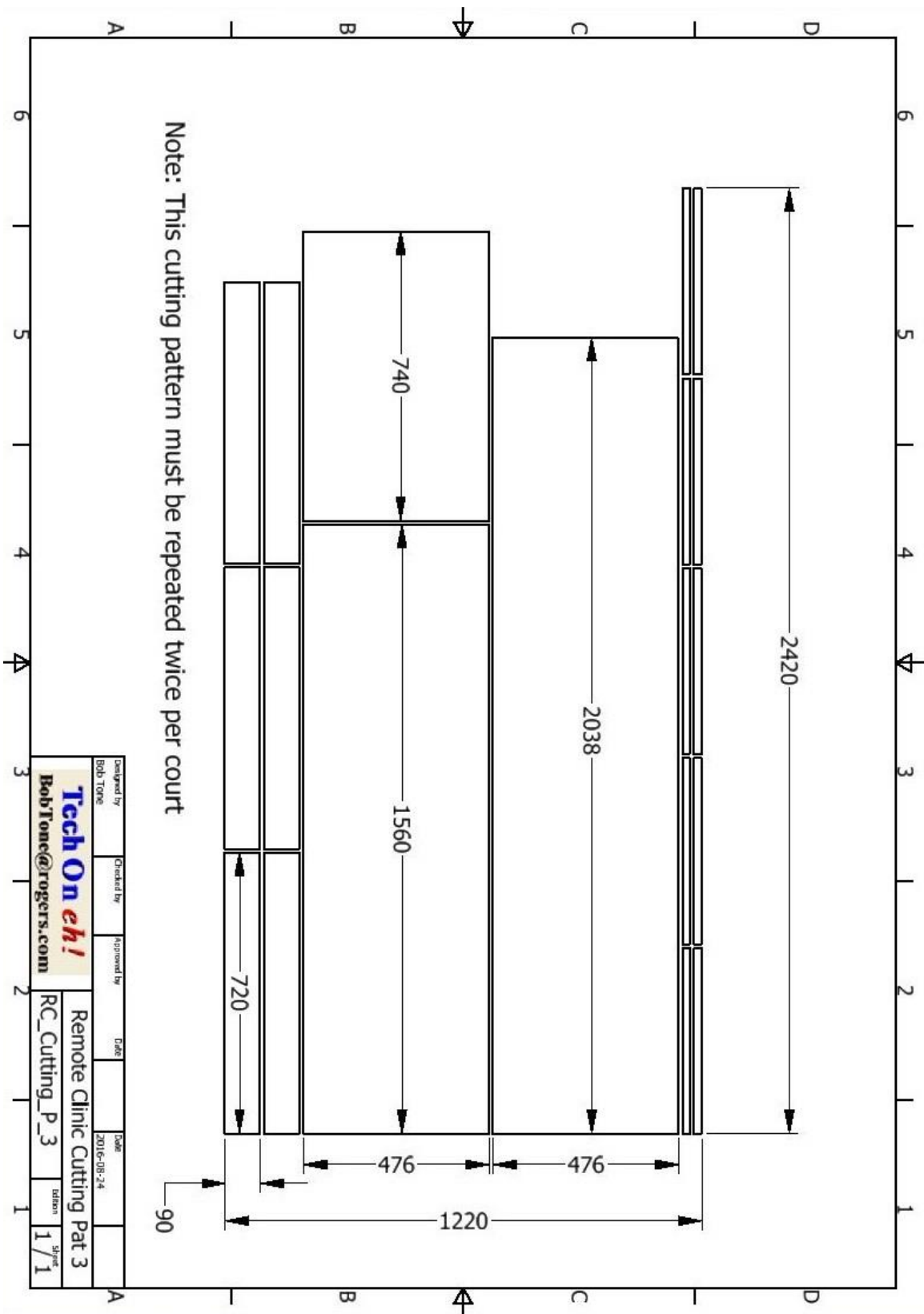

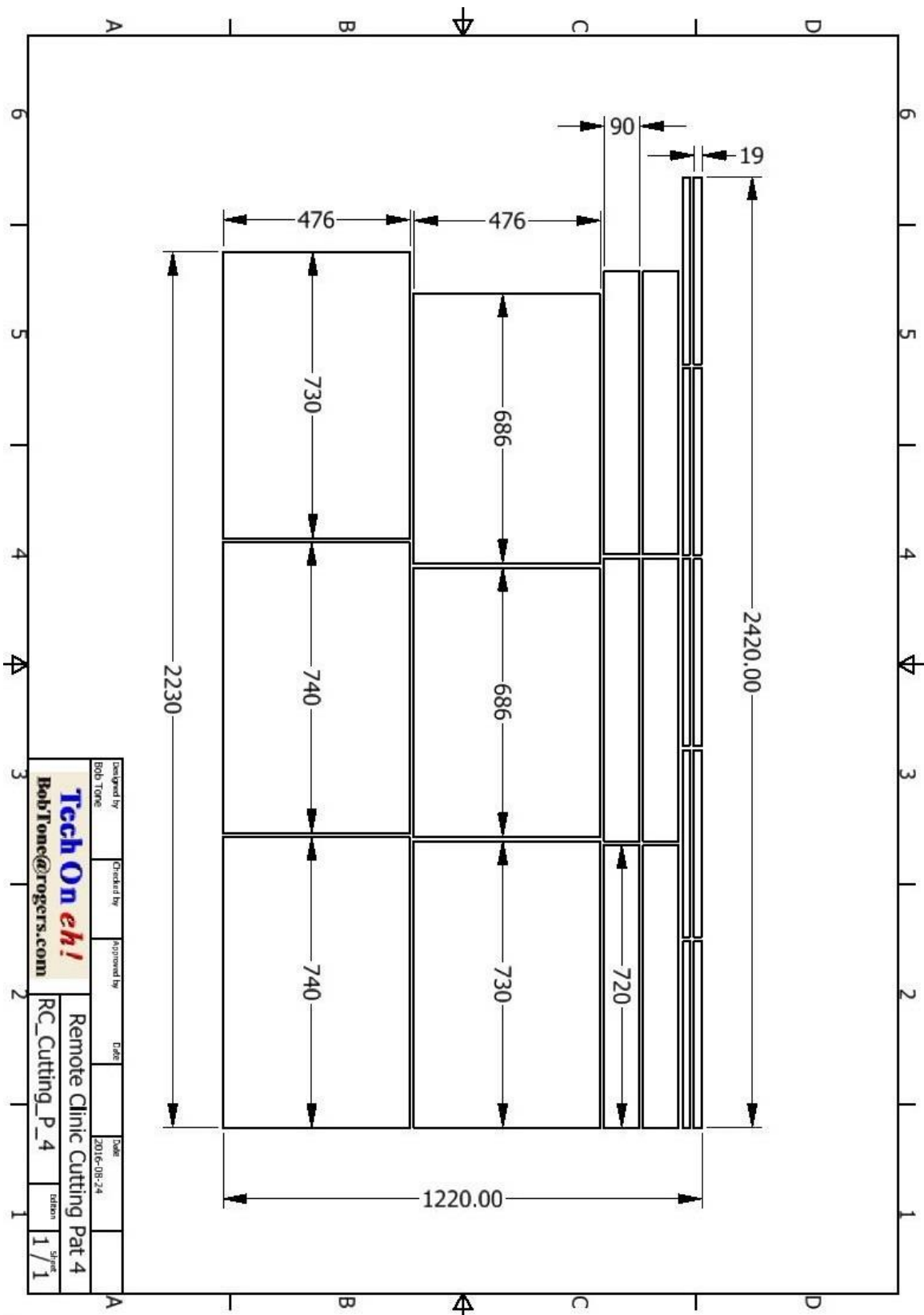

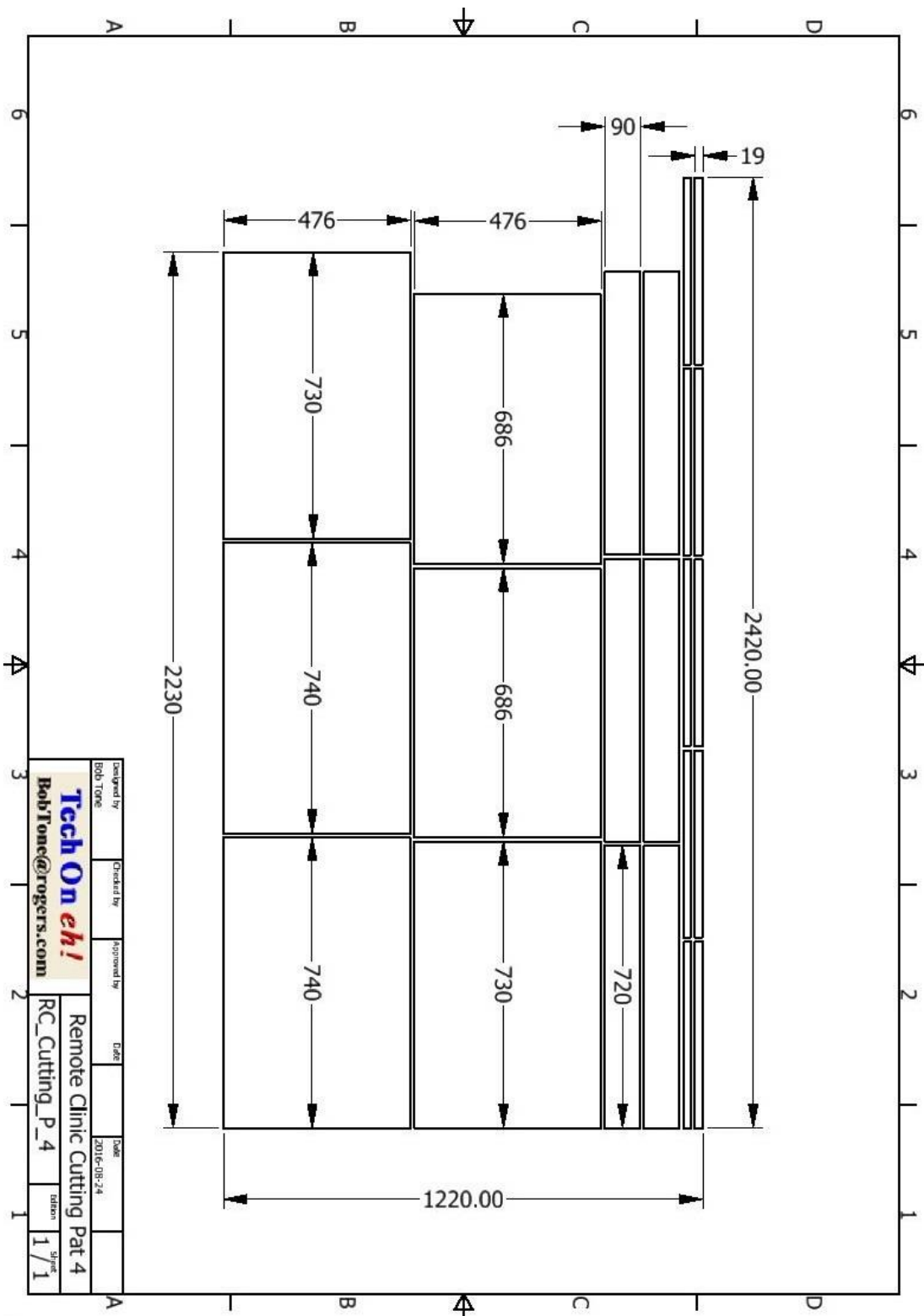

Note: Two additional sheets of 1220 by 2440 mm Melamine Sheets can be used to build the Object Avoidance Court, but the exact specs will not be shared on the Pre-Test Project.